

SX Series

Low Cost Pressure Sensors

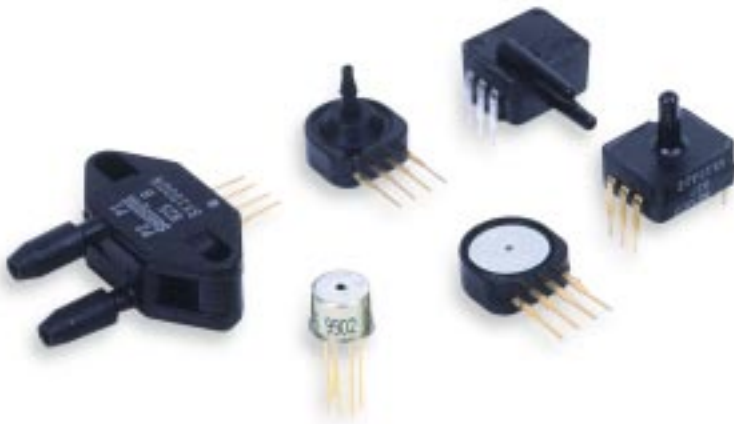

The SX Series of pressure sensors provide the lowest cost components for measuring pressures up to 150 psi. These sensors were specifically designed for use with non-corrosive, non-ionic media, such as air, dry gases, and the like. Convenient pressure ranges are available to measure differential, gauge, and absolute pressures from 0 to 1 psi (SX01) up to 0 to 150 psi (SX150).

The Absolute (A) devices have an internal vacuum reference and an output voltage proportional to absolute pressure. The Differential (D) devices allow application of pressure to either side of the diaphragm and can be used for gauge or differential pressure measurements.

This product is packaged either in SenSym ICT's standard low cost chip carrier "button" package, a plastic ported "N" package, or a metal TO5 Package with or without gel. All packages are designed for applications where the sensing element is to be integral to the OEM equipment. These packages can be o-ring sealed, epoxied, and/or clamped onto a pressure fitting. A closed-bridge four-pin SIP configuration is provided for electrical connection to the "Button" or "N" Package. The TO5 Package offers a 5-pin open-bridge configuration. A DIP Package is also available, which mounts on a PC board like a standard IC with through-hole pins. This extremely small size package enables the use of multiple sensors in a limited available space application.

Because of its high-impedance bridge, the SX Series is ideal for portable and low power or battery operated systems. Due to its low noise, the SX is an excellent choice for medical and other low pressure applications.

Contact your local SenSym ICT representative, the factory, or go to SenSym ICT's Web site at www.sensym-ict.com for additional details.

APPLICATIONS

- Medical Instrumentation
- Barometric Measurement
- Pneumatic Controls
- Battery Powered Equipment

FEATURES

- Low Cost
- High-Impedance Bridge
- Absolute and Differential (Gauge)
- Low Noise
- Low Power Consumption for Battery Power

EQUIVALENT CIRCUITS

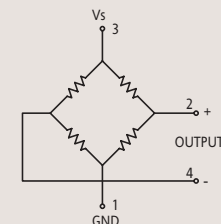

BUTTON, NIPPLE AND "N" PACKAGE

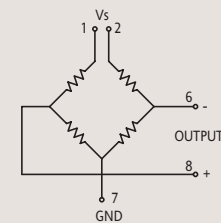

TO AND DIP PACKAGE

SX Series

PRESSURE SENSOR CHARACTERISTICS

Maximum Ratings (For All Devices)

Supply Voltage, V_S	+12 Vdc
Temperature Ranges:	
Operating	-40°C to +85°C
Storage	-55°C to +125°C
Common-Mode Pressure	150 psig
Lead Soldering Temperature (2-4 Seconds)	250°C

PERFORMANCE CHARACTERISTICS⁽¹⁾

Characteristics	Min	Typ	Max	Unit
Zero Pressure Offset ⁽⁵⁾	-35	-20	0	mV
Temperature Coefficient of Offset ^(6,9)	-	+4	-	$\mu\text{V}/\text{V}/^\circ\text{C}$
Combined Pressure Non-Linearity and Pressure Hysteresis ⁽³⁾	-	0.2	± 0.5	%FSS
Long Term Stability of Offset & Span ⁽⁸⁾	-	0.1	-	%FSS
Response Time ⁽⁷⁾	-	100	-	μsec
Input Resistance	-	4.1	-	$\text{k}\Omega$
Temperature Coefficient of Resistance ^(6,9)	+690	+750	+810	$\text{ppm}/^\circ\text{C}$
Temperature Coefficient of Span ^(6,9)	-2550	-2150	-1900	$\text{ppm}/^\circ\text{C}$
Output Resistance	-	4.1	-	$\text{k}\Omega$
Repeatability ⁽⁴⁾	-	0.5	-	%FSS

SX PERFORMANCE CHARACTERISTICS⁽¹⁾

Part Number	Operating Pressure (psi)	Sensitivity (mV/V/psi)	Full-Scale Span ⁽²⁾ (mV)			Burst Pressure (psi)
			Typ	Min	Typ	
SX01	0-1	4.0	15	20	25	20
SX05	0-5	3.0	50	75	100	20
SX15	0-15	1.5	75	110	150	45
SX30	0-30	0.75	75	110	150	90
SX100	0-100	0.3	100	150	200	150
SX150	0-150	0.15	75	110	150	200

*Maximum Pressure above which can cause permanent sensor failure

ORDERING INFORMATION

To order, use the following part number(s):

Pressure Range	Order Part Number				
	Button Package	Nipple Package	"N" Package	TO Package	DIP Package
0 to 1 psid or psig	SX01D	SX01DP1	SX01DN	SX01GSO	SX01GD2, SX01DD4
0 to 5 psid or psig	SX05D	SX05DP1	SX05DN	SX05GSO	SX05GD2, SX05DD4
0 to 15 psia	SX15A	SX15AP1	SX15AN	SX15AHO	SX15AD2, SX15AD4
0 to 30 psia	SX30A	SX30AP1	SX30AN	SX30AHO	SX30AD2, SX30AD4
0 to 100 psia	SX100A	-	SX100AN	SX100AHO	SX100AD2, SX100AD4
0 to 150 psia	SX150A	-	SX150AN	SX150AHO	-
0 to 15 psid or psig	SX15D	SX15DP1	SX15DN	SX15GSO	SX15GD2, SX15DD4
0 to 30 psid or psig	SX30D	SX30DP1	SX30DN	SX30GSO	SX30GD2, SX30DD4
0 to 100 psid or psig	SX100D	-	SX100DN	SX100GSO	SX100GD2, SX100DD4
0 to 150 psid or psig	SX150D	-	-	SX150GSO	-

SPECIFICATION NOTES (for all devices)

- Note 1: Reference Conditions:
 $T_A = 25^\circ\text{C}$
 Supply
 $V_S = 5 \text{ Vdc}$
 Common Line Pressure = 0 psig
 Pressure Applied to P1
- Note 2: Full-Scale Span is the algebraic difference between the output voltage at full-scale pressure and the output at zero pressure. Full-Scale Span is ratiometric to the supply voltage.
- Note 3: Pressure Hysteresis - the maximum output difference at any point within the operating pressure range for increasing and decreasing pressure. Pressure Non-Linearity - the maximum deviation of measure output, at constant temperature (25°), from "best straight line" through three points (offset pressure, full-scale pressure, one-half full-scale pressure).
- Note 4: Maximum difference in output at any pressure within the operating pressure range and the temperature range within 0°C to $+70^\circ\text{C}$ after:
 a) 100 temperature cycles, 0°C to $+70^\circ\text{C}$
 b) 1 million pressure cycles, 0 psi to Full-Scale Span
- Note 5: The zero pressure offset is 0 mV Min, 20 mV Typ and 35 mV Max for part numbers SXxxxGD2 and SXxxxDD4.
- Note 6: Slope of best straight line fit from 0°C to 70°C . For operation outside this temperature range, contact factory for more information.
- Note 7: Response time for a 0 psi to Full-Scale Span pressure step change, 10% to 90% rise time.
- Note 8: Long term stability over a one year period.
- Note 9: This parameter is not 100% tested. It is guaranteed by process design.

ELECTRICAL CONNECTIONS

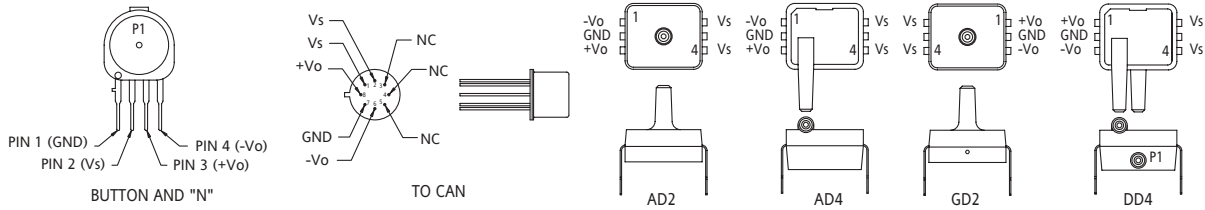

PACKAGE OUTLINES

Button Package

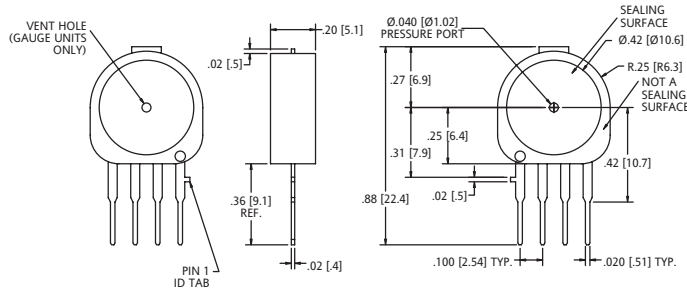

Nipple Package

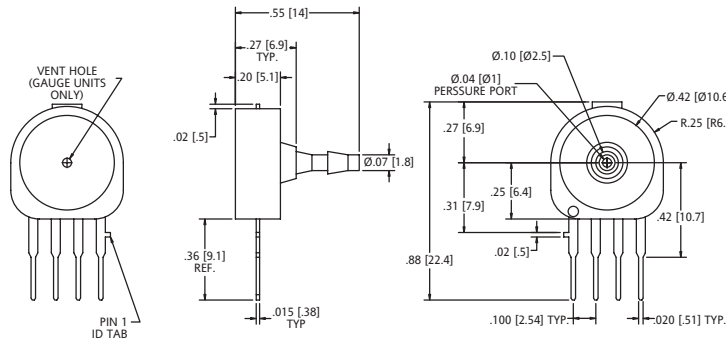

N Housing Package

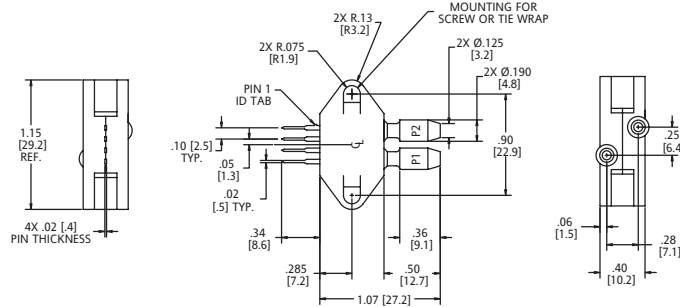

D2 Dip Package

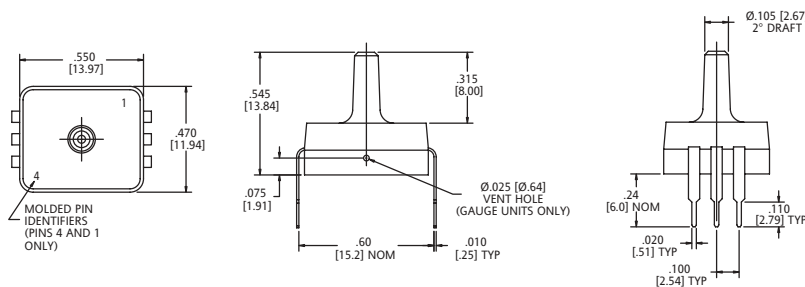

SX Series

Low Cost Pressure Sensors

PACKAGE OUTLINES (con't)

DD4 Dip Package

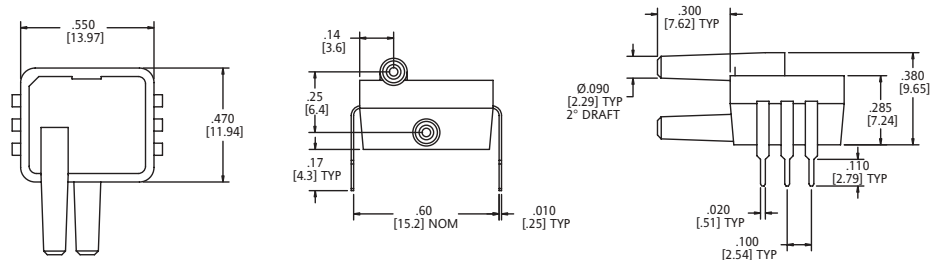

AD4 Dip Package

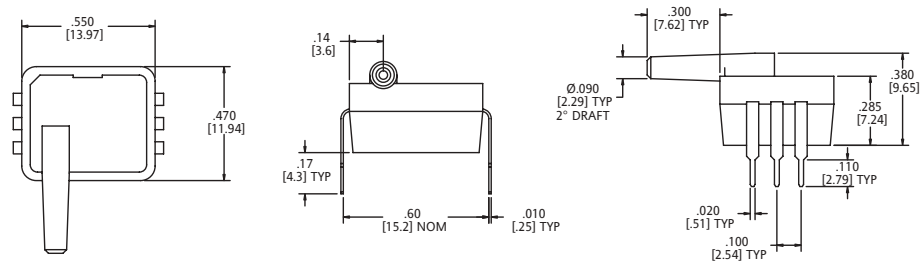

T05 Package

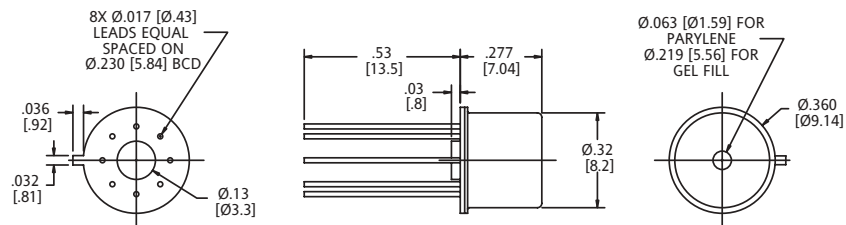

T039 Package

